

Data Sheet



Article number: 025799300070

Description: Norma Connect pipe coupling
GRIP E W5 Ø=70,0 EPDM, 16 bar

Measures

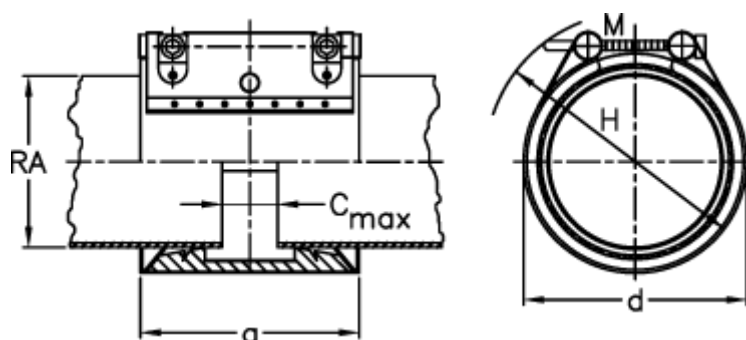

a	= 98
C max with insertion band	= 25
d	= 90
H	= 110
M (screw)	= M10
Nominal pressure (bar)	= 16
RA	= 70
RA min-RA max	= 69,0-71,0

Weight a piece = 1.2